

NAIS

THE SLIM POWER RELAY

PA-RELAYS

FEATURES

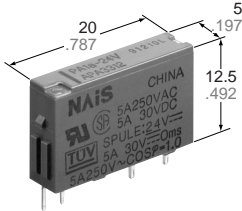

mm inch

- Slim size (width 5 mm .197 inch, height 12.5 mm .492 inch) permits higher density mounting
- Wide switching capacity: Control from 100µA 100 mV to 5 A 250 V AC, 30 V DC
- High sensitivity: 120 mW (Nominal) (5 to 18 V DC type)
- High surge voltage (4000 V) and high breakdown voltage (2000 V)
- Shock & vibration resistance (functional): Min. 147m/s² {15 G}
- SIL (single in line) terminal layout
- Reinforced according to IEC1131-2 (TÜV)

SPECIFICATIONS (at 20°C 68°F)

Contacts

Arrangement	1a	
Contact material	Gold-clad silver alloy	
Initial contact resistance, max. (By voltage drop 6 V DC 1 A)	30 mΩ	
Rating (resistive)	Nominal switching capacity	5 A 250 V AC, 5 A 30 V DC
	Maximum switching power	750 VA, 90 W
	Maximum switching voltage	250 V AC, 110 V DC
	Max. switching current	5 A
	Min. switching capacity	100µA, 100 mV DC
Expected life (min. operations)	Mechanical	2×10 ⁷
	Electrical (at 20 cpm)	3 A 250 V AC, 3 A 30 V DC, 10 ⁵ 5 A 250 V AC, 5 A 30 V DC, 5×10 ⁴

Coil (at 25°C 77°F, 50% R.H.)

Nominal operating power	5 to 18 V DC	120 mW
	24 V DC	180 mW

Remarks

- * Specifications will vary with foreign standards certification ratings.
- *1 Measurement at same location as "Initial breakdown voltage" section
- *2 Detection current: 10mA
- *3 Wave is standard shock voltage of ±1.2×50µs according to JEC-212-1981
- *4 Excluding contact bounce time
- *5 Half-wave pulse of sine wave: 11ms; detection time: 10µs
- *6 Half-wave pulse of sine wave: 6ms
- *7 Detection time: 10µs
- *8 Refer to 5. Conditions for operation, transport and storage mentioned in AMBIENT ENVIRONMENT (Page 61).

Characteristics

Max. operating speed	20 cpm at rated load	
Initial insulation resistance* ¹	Min. 1,000 MΩ at 500 V DC	
Initial break-down voltage* ²	Between open contacts	1,000 Vrms
	Between contacts and coil	2,000 Vrms
Surge voltage between contacts and coil* ³	4,000 V	
Operate time* ⁴ (at nominal voltage)	Approx. 6 ms	
Release time (without diode)* ⁴ (at nominal voltage)	Approx. 3 ms	
Temperature rise	Max. 45°C with nominal coil voltage across coil and at nominal switching capacity	
Shock resistance	Functional* ⁵	Min. 147 m/s ² {15 G}
	Destructive* ⁶	Min. 980 m/s ² {100 G}
Vibration resistance	Functional* ⁷	Min. 147 m/s ² {15 G}, 10 to 55 Hz at double amplitude of 2.5 mm
	Destructive	Min. 205.8 m/s ² {21 G}, 10 to 55 Hz at double amplitude of 3.5 mm
Conditions for operation, transport and storage* ⁸ (Not freezing and condensing at low temperature)	Ambient temp.	-40°C to +70°C -40°F to +158°F
	Humidity	5 to 85%R.H.
Unit weight	Approx. 3 g .15 oz	

TYPICAL APPLICATIONS

- Interface relays for programmable controllers
- Output relays for measuring equipment, timers, counters and temperature controllers
- Industrial equipment, office equipment

ORDERING INFORMATION

Ex. PA 1a — 12V

Contact arrangement	Coil voltage (DC)
1a: 1 Form A	5, 6, 9, 12, 18, 24V

Note: Standard packing: Tube: 25 pcs.; Case: 1,000 pcs.
UL/CSA, TÜV approved type is standard.

TYPES AND COIL DATA (at 20°C 68°F)

Part No.	Nominal voltage, V DC	Pick-up voltage,* V DC (max.)	Drop-out voltage,* V DC (min.)	Nominal operating current, mA (±10%)	Nominal operating power, mW	Coil resistance, Ω (±10%)	Max. allowable voltage, V DC
PA1a-5VV	5	3.5	0.25	24	120	208	6
PA1a-6VV	6	4.2	0.3	20	120	300	7.2
PA1a-9VV	9	6.3	0.45	13.3	120	675	10.8
PA1a-12V	12	8.4	0.6	10	120	1,200	14.4
PA1a-18V	18	12.6	0.9	6.7	120	2,700	21.6
PA1a-24V	24	16.8	1.2	7.5	180	3,200	28.8

*1 Pulse driving

DIMENSIONS

1. PA relay

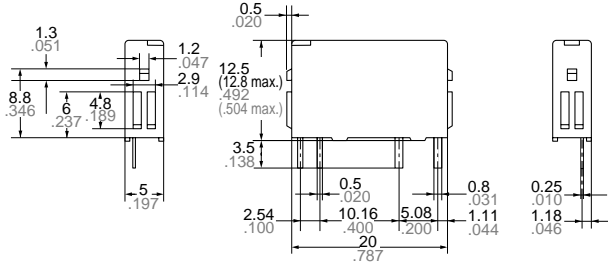

General tolerance: $\pm 0.3 \pm 0.12$

PC board pattern (Copper-side view)

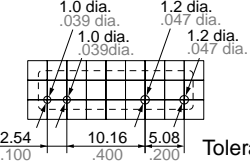

Schematic (Bottom view)

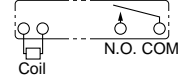

2. Socket



PA1a-PS

Standard type

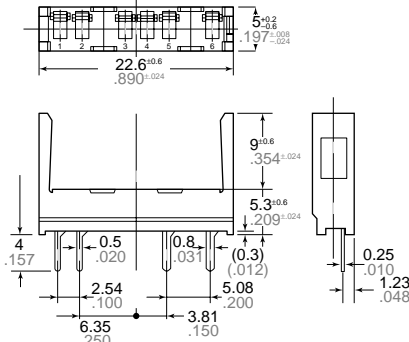

PA1a-PS

Self clinching type

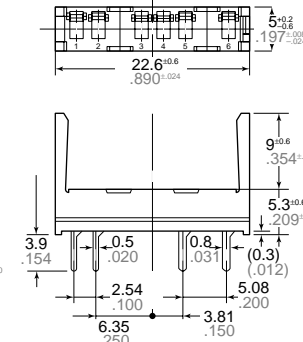

PA1a-PS-H

PC board pattern (Copper-side view)

Standard type

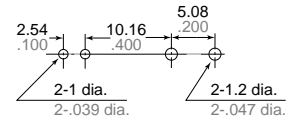

Self clinching type

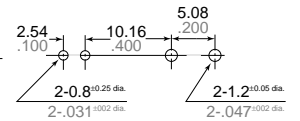

Tolerance: $\pm 0.1 \pm 0.04$

REFERENCE DATA

1. Max. switching capacity

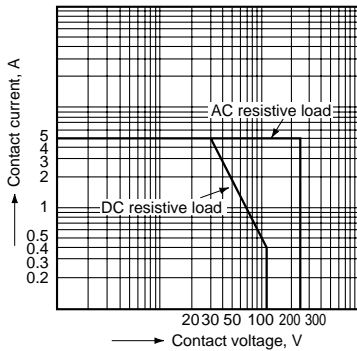

2. Life curve

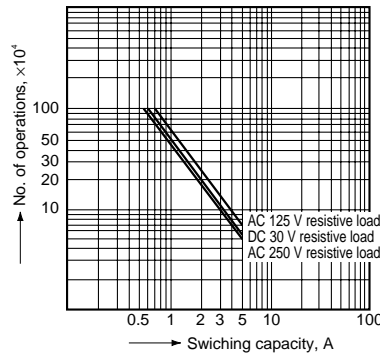

3.-(1) Coil temperature rise (120 mW)

Sample: PA1a-12V
 Ambient temperature: 20°C 68°F
 Measured portion: Inside the coil

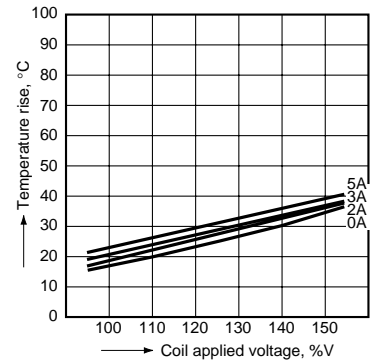

3.-(2) Coil temperature rise (180 mW)

Sample: PA1a-24V
 Ambient temperature: 20°C 68°F
 Measured portion: Inside the coil

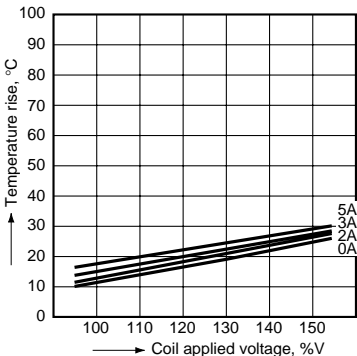

4.-(1) Operate & release time (120 mW)

Sample: PA1a-12V
 No. of samples: n = 20

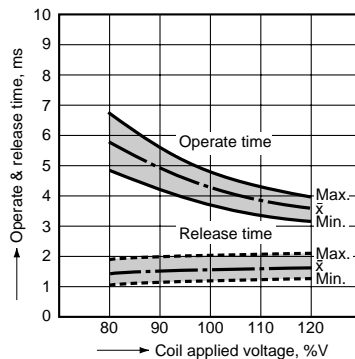

4.-(2) Operate & release time (180 mW)

Sample: PA1a-24V
 No. of samples: n = 20

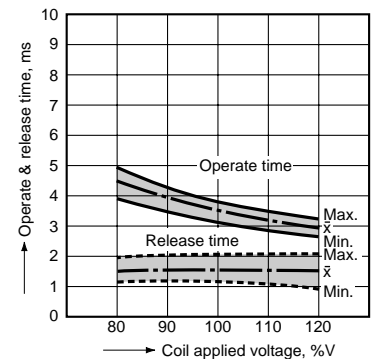

5. Ambient temperature characteristics

Sample: PA1a-12V
No. of samples: n = 6

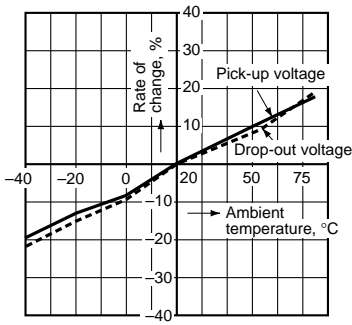

6. Malfunctional shock

Sample: PA1a-12V
No. of samples: n = 6

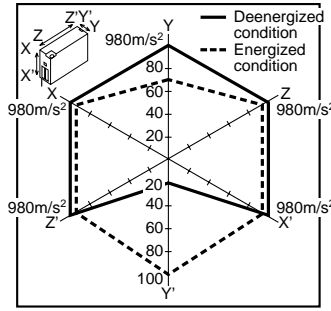

NOTES

1. Specification values for pick-up and drop-out voltages are for the relay mounting with its terminals below.

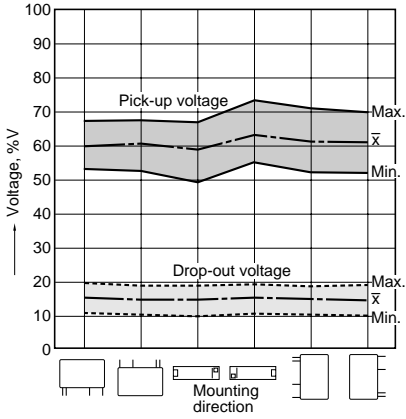

2. When mounting the relays within 1 mm. .039 inch, please notice the condition below.

1) Mount the relays in the same direction.

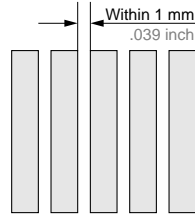

2) Coil terminals (Terminal No. 1 & 2) polarity should be arranged in the same direction.

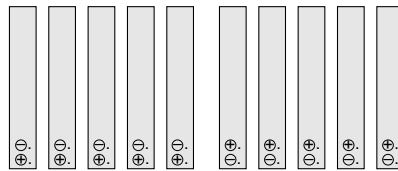

3) Allowable contact current is 2 A.

4) About the electrical life for close mounting, please refer to data below.

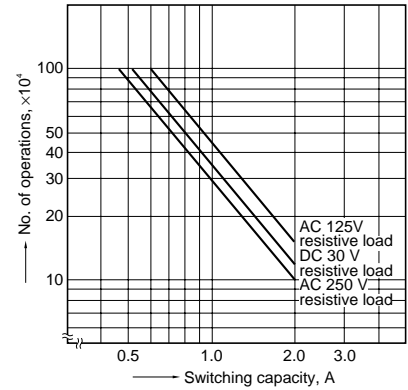
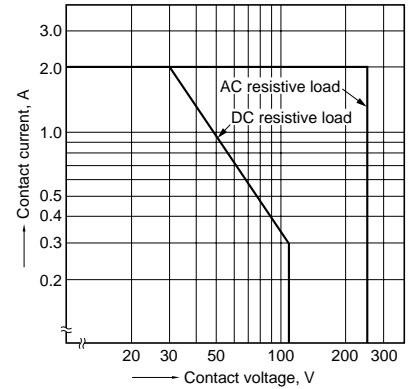

For Cautions for Use, see Relay Technical Information (Page 48 to 76).