

All Purpose Reed Relays



DESCRIPTION

- Large assortment of pin out schemes
- High life expectancy
- Low thermal versions available

APPLICATIONS

- Telecommunications
- Medical equipment
- Test and Measurement
- General applications

FEATURES

- Up to 5 switches in a package (Consult factory)
- Normally closed option
- Insulation resistance up to $10^{14} \Omega$ available
- Metal and Plastic casings available
- Latching version available
- 4.5 kVDC (3.0 kVRMS) contact to coil option
- High contact to coil voltage

DIMENSIONS

All dimensions in mm [inches]

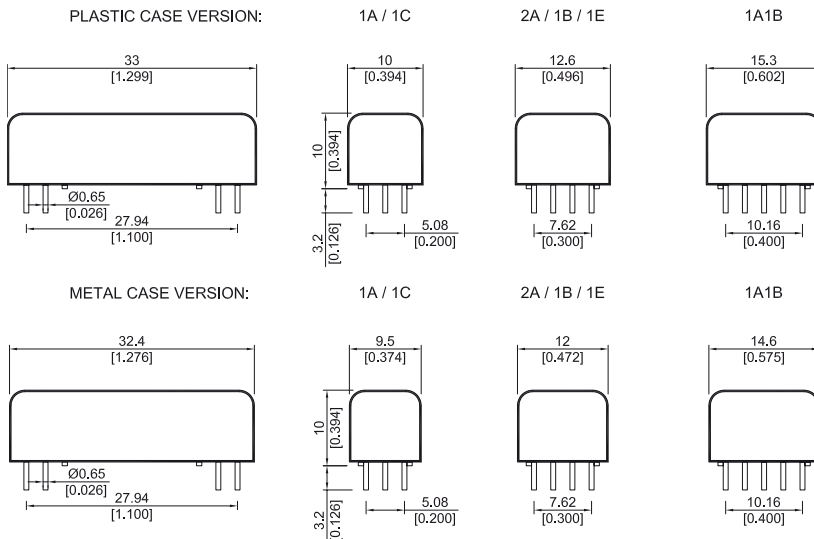

ORDER INFORMATION

Series	Nominal Voltage	Contact Form	Switch Model	Pin Out	Casing option (p, m, v) *	High ** Insulation resistance
BE	XX -	XX	XX -	XX	X	XX
Options	05, 12, 24	1A	66, 85	10	P, M	HI
			66	11	V	
	05, 12, 24	1B	66	10	M	
			66	11	V	
	05, 12, 24	1C	90	15	P, M	
	05, 12	1E	66	14	M	
05, 12, 24	2A	66, 85	20	P, M		
05, 12, 24	1A1B	66	23	M		

* P = plastic, M = metal, V = High isolation voltage
 Please note: Selecting option V offers 4,5 kV breakdown voltage contact to coil, but only for pin out 11.
 ** Selects the $10^{14} \Omega$ option between contact to coil and plastic case.

Part Number Example

BE05 - 1A85 - P

05 is the nominal voltage
1A is the contact form
85 is the switch model
P is the casing

PIN OUT

View from top of component
 2.54mm [0.10"] pitch grid

10

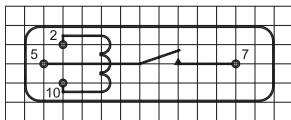

→ **UP**
 ONLY WHEN USING THE
 MERCURY WETTED (88) SWITCH

11

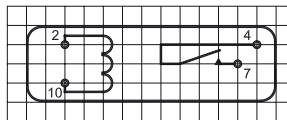

4.5 kVDC

14

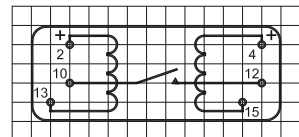

Coil 1

Coil 2

15

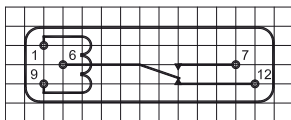

20

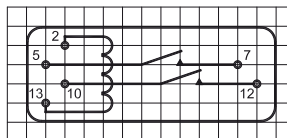

→ **UP**
 ONLY WHEN USING THE
 MERCURY WETTED (88) SWITCH

23

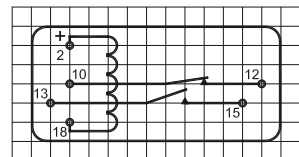

All Purpose Reed Relays

RELAY DATA

All Date at 20° C	Switch Model → Contact Form →	Switch 66 Form A / B			Switch 85 Form A			Units
		Min.	Typ.	Max.	Min.	Typ.	Max.	
Contact Ratings	Conditions							
Switching Power *	Any DC combination of V & A not to exceed their individual max.'s			10			100	W
Switching Voltage	DC or peak AC			200			1000	V
Switching Current	DC or peak AC			0.5			1.0	A
Carry Current	DC or peak AC			1.25			2.5	A
Static Contact Resistance	w/ 0.5 V & 10 mA			150			150	mΩ
Dynamic Contact Resistance	Measured w/ 0.5 V & 50 mA , 1.5 ms after closure			200			200	mΩ
Insulation Resistance (100 Volts applied)	Across contacts Contact to coil	10 ¹⁰ 10 ¹²			10 ¹² 10 ¹²			Ω
Breakdown Voltage	Across contacts Contact to coil	225 2.0 *			4000 2.0			VDC kVDC
Operate Time incl. Bounce	Measured w/ 100 % overdrive			0.5			1.0	ms
Reset Time	Measured w/ no coil suppression			0.1			0.1	ms
Capacitance	Across contacts Contact to coil		0.2 5.0			0.2 5.0		pF
Life Expectancies								
Switching 5V & 10 mA	DC only & <10 pF stray cap.		1000			500		10 ⁶ Cycles
For other load requirements, see the life test section on P. 121.								
Environmental Data								
Shock Resistance	1/2 Sine wave duration 11ms			50			50	g
Vibration Resistance	10 - 2000 Hz			20			20	g
Ambient Temperature	10°C/minute max. allowable	-20		70	-20		70	°C
Storage Temperature	10°C/minute max. allowable	-40		105	-40		105	°C
Soldering Temperature	5 sec. dwell			260			260	°C
* 4.5 kVDC / 3.0 kVRMS when the V option is selected.								

RELAY DATA

All Data at 20° C	Switch Model → Contact Form →	Switch 90 Form C			
Contact Ratings	Conditions	Min.	Typ.	Max.	Units
Switching Power *	Any DC combination of V & A not to exceed their individual max.'s			10	W
Switching Voltage	DC or peak AC			175	V
Switching Current	DC or peak AC			0.25	A
Carry Current	DC or peak AC			1.2	A
Static Contact Resistance	w/ 0.5 V & 50 mA			150	mΩ
Dynamic Contact Resistance	Measured w/ 0.5 V & 50 mA , 1.5 ms after closure			250	mΩ
Insulation Resistance (100 Volts applied)	Across contacts Contact to coil	10 ⁹ 10 ¹²			Ω
Breakdown Voltage	Across contacts Contact to coil	200 2000			VDC
Operate Time incl. Bounce	Measured w/ 100 % overdrive			0.7	ms
Reset Time	Measured w/ no coil suppression			1.5	ms
Capacitance	Across contacts Contact to coil		1.0 5.0		pF
Life Expectancies					
Switching 5V & 10 mA	DC only & <10 pF stray cap.		100		10 ⁶ Cycles
For other load requirements, see the life test section on P. 121.					
Environmental Data					
Shock Resistance	1/2 Sine wave duration 11ms			50	g
Vibration Resistance	10 - 2000 Hz			20	g
Ambient Temperature	10°C/minute max. allowable	-20		70	°C
Storage Temperature	10°C/minute max. allowable	-40		105	°C
Soldering Temperature	5 sec. dwell			260	°C

All Purpose
Reed Relays

COIL DATA

Contact Form	Switch Model	Coil Voltage		Coil Resistance	Pull-In Voltage	Drop-Out Voltage	Nominal Coil Power
All Data at 20 °C *		VDC		Ω	VDC	VDC	mW
		Nom.	Max.	Typ. **** Tolerance ± 10%	Max.	Min.	Typ.****
1A	66	5	7.5	140 (345)	3.5	0.75	179 (72)
		12	16	855 (2145)	8.4	1.8	168 (67)
		24	30	3285 (7845)	16.8	3.6	175 (73)
	85	5	7.5	105 (140)	3.5	0.75	238 (179)
		12	16	620 (1000)	8.4	1.8	232 (144)
		24	30	1400 (2300)	16.8	3.6	411 (250)
1B **	66	5	7.5	(180)	3.5	0.75	139
		12	16	(1100)	8.4	1.8	131
		24	30	(4240)	16.8	3.6	136
1C	90	5	7.5	345	3.5	0.75	72
		12	16	2145	8.4	1.8	67
		24	30	7845	16.8	3.6	73
1E ***	66	5	7.5	2 x 850	3.5	0.75	29
		12	16	2x 5060	8.4	1.8	28
2A	66	5	7.5	70 (180)	3.5	0.75	357 (139)
		12	16	445 (1100)	8.4	1.8	324 (131)
		24	30	1700 (4240)	16.8	3.6	339 (136)
	85	5	7.5	70 (110)	3.5	0.75	357 (227)
		12	16	420 (600)	8.4	1.8	343 (240)
		24	30	1080 (1600)	16.8	3.6	533 (360)
1A1B**	66	5	7.5	(55)	3.5	0.75	455
		12	16	(370)	8.4	1.8	424
		24	30	(1350)	16.8	3.6	427

* The pull-in / drop-out voltage and coil resistance will change at the rate of 0,4 % per degrees C.
** Reclosure of Form B may occur if the max. voltage is exceeded. Coil polarity on Form B must be observed. Pin 2 is positive.
*** Coil polarity must be observed. Applying a 2 ms pulse to Coil No. 1 with nominal voltage will latch the contacts.
Applying a 2 ms pulse to Coil No. 2 will unlatch the contacts.
**** The figures in brackets are for relays in metal casing.